

EG 1661 processor shown with extra receiving table

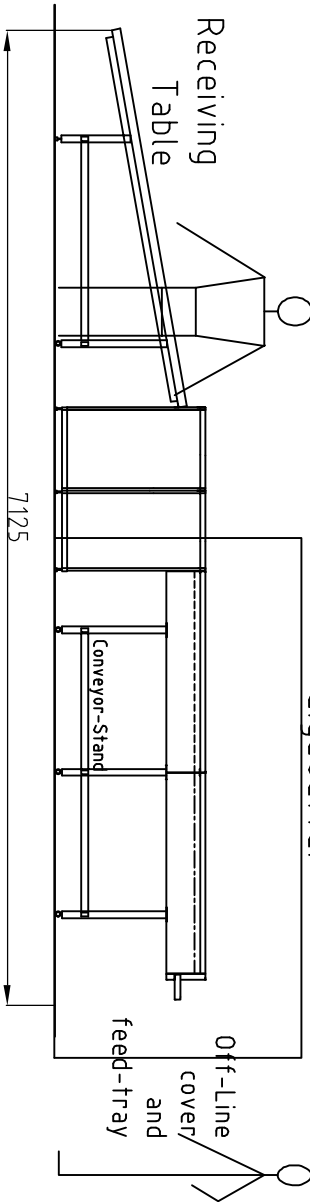

BG76830 / BG76860 GigaSetter

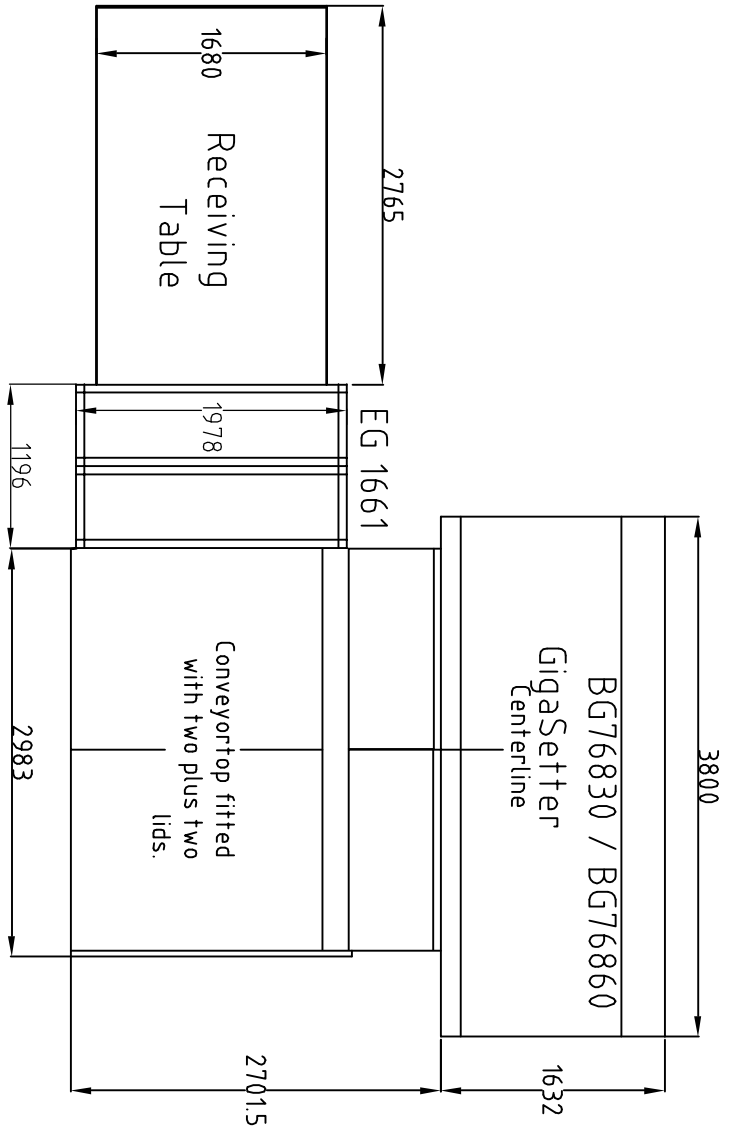
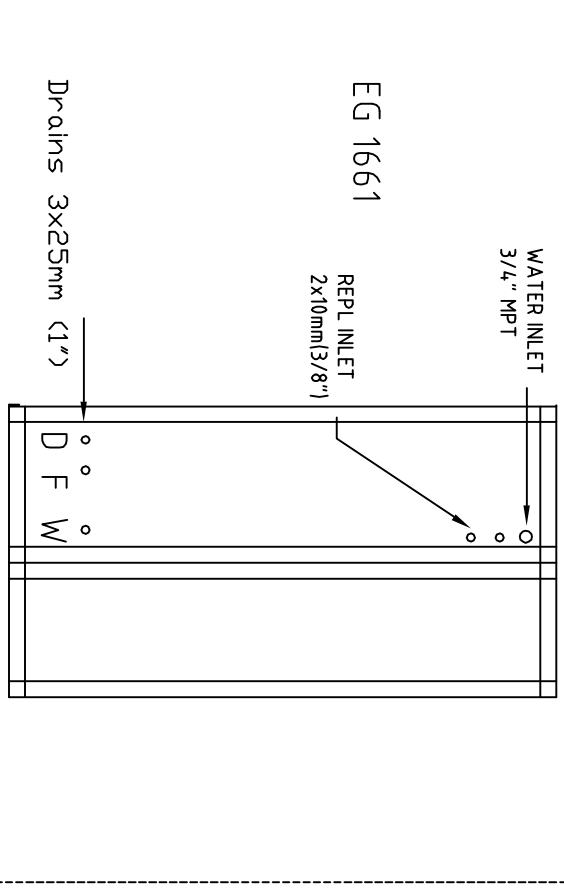
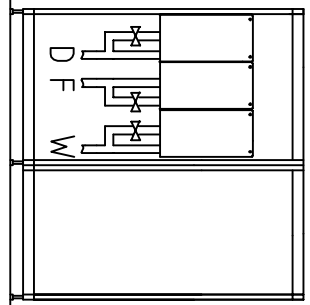
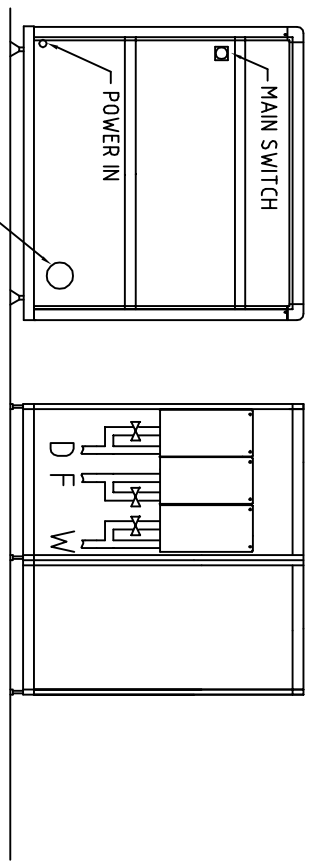

Echo Graphic A/S
 Haandværkervej 2
 DK-9560 Hadsund,
 Phone int.: +45 98 57 19 55
 Fax int.: +45 98 57 15 91

Design/Draw : CV
 Scale : 1:54
 Installation view EG1661- RH from Giga.
 Name :
 BG76830 / BG76860 , GigaSetter

Date : 11-08-03
 Drawing no. :
 6357-RH

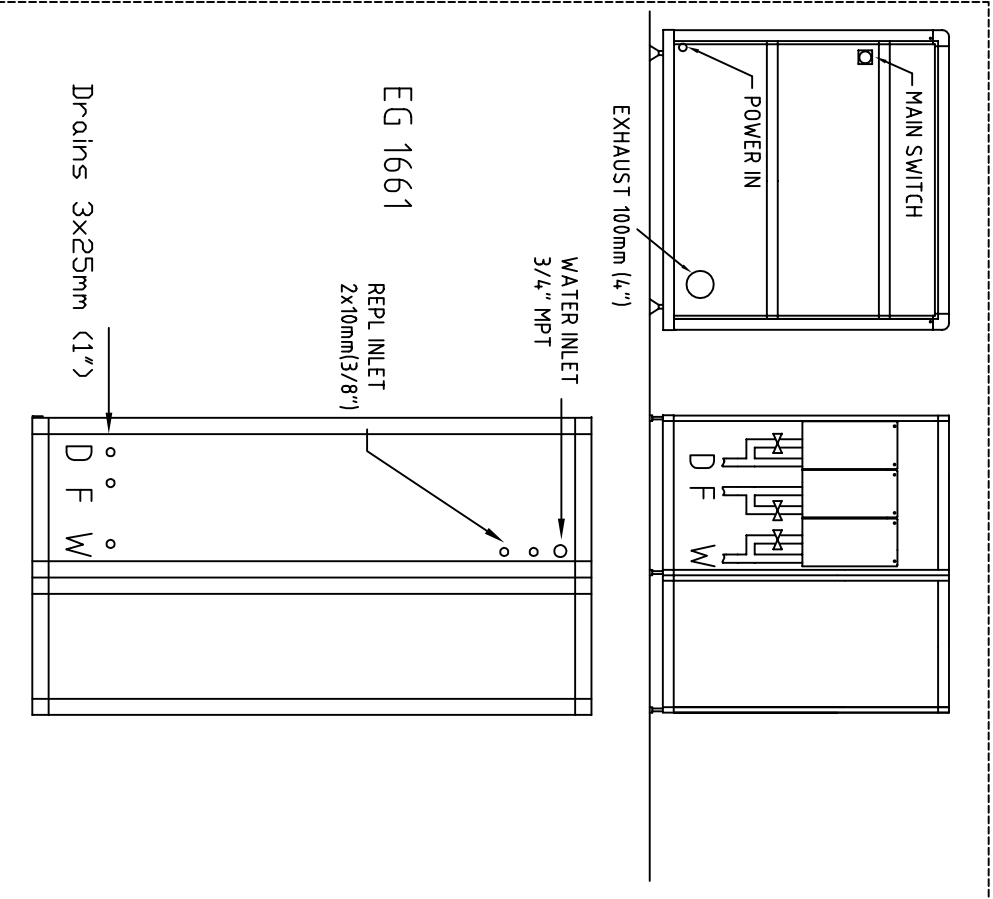
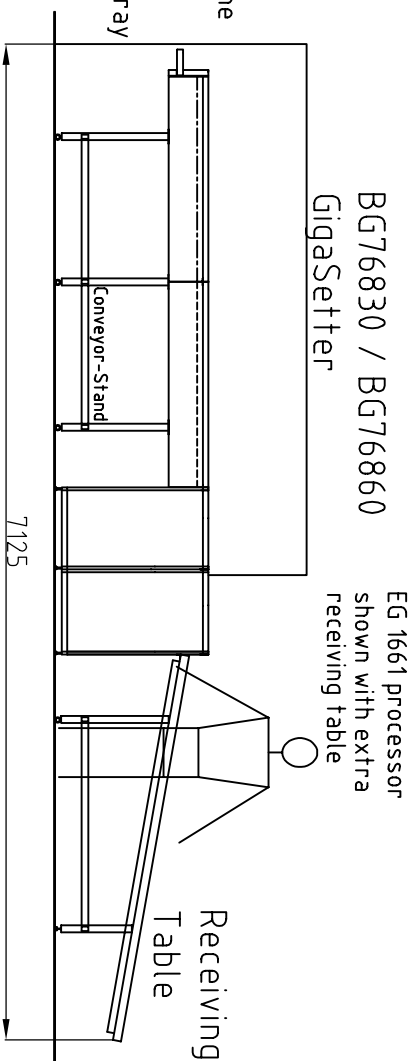
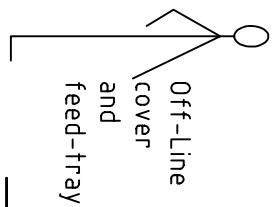
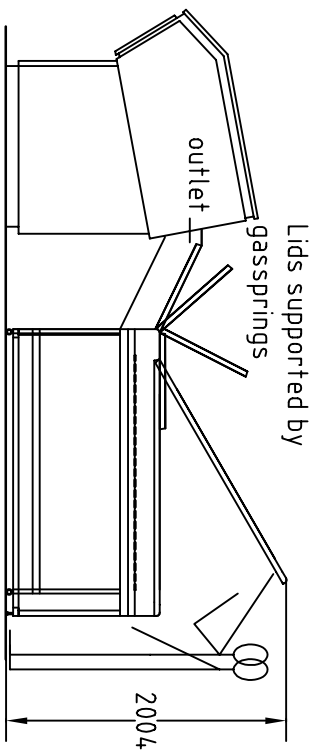

Echo Graphic A/S
 Haandværkervej 2
 DK-8560 Hadsund,
 Phone int.: +45 98 57 19 55
 Fax int.: +45 98 57 15 91

Design/Draw : CV	Scale : 1:54	Date : 11-08-03
Installation view EG1661		Drawing no. : 6357
Name : BG76830 / BG76860, gigasetter		